

ASSEMBLY INSTRUCTION

PLEASE READ BEFORE ASSEMBLING!

Tip #1: Make sure you've taken all the pieces and hardware out of its packaging before discarding the box. Assembly on top of flattened box/blanket is recommended.

Tip #2: Using page 2 and/or page 3 of instruction manual make sure all pieces and hardware are accounted for.

Tip #3: Note position of all holes on each panel during assembly.

ITEM#: 8086-3

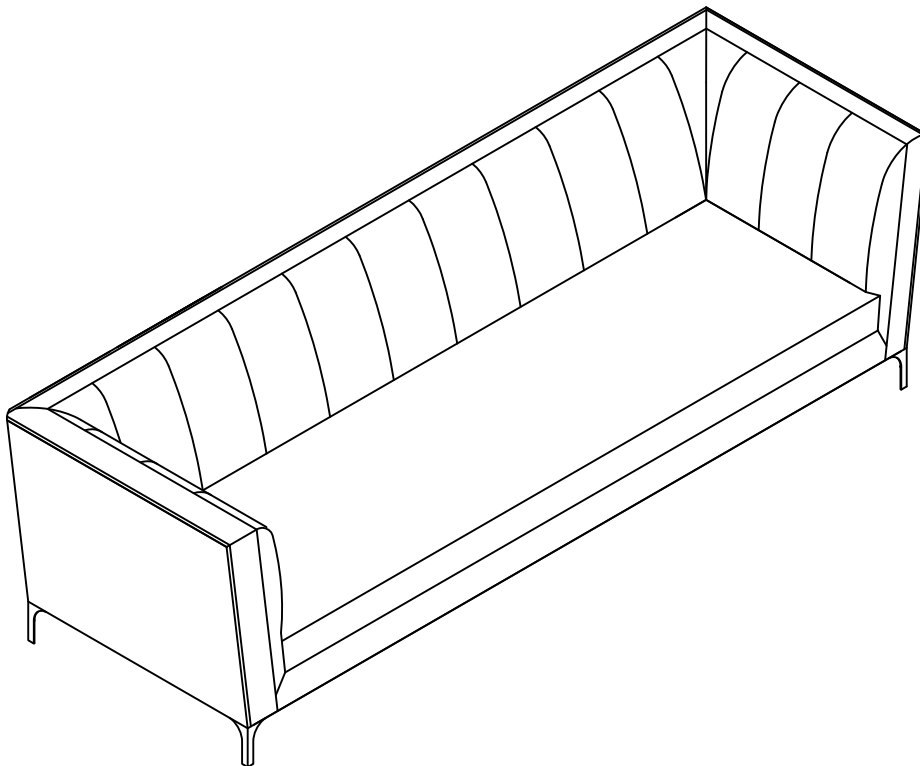

PARTS IDENTIFICATION



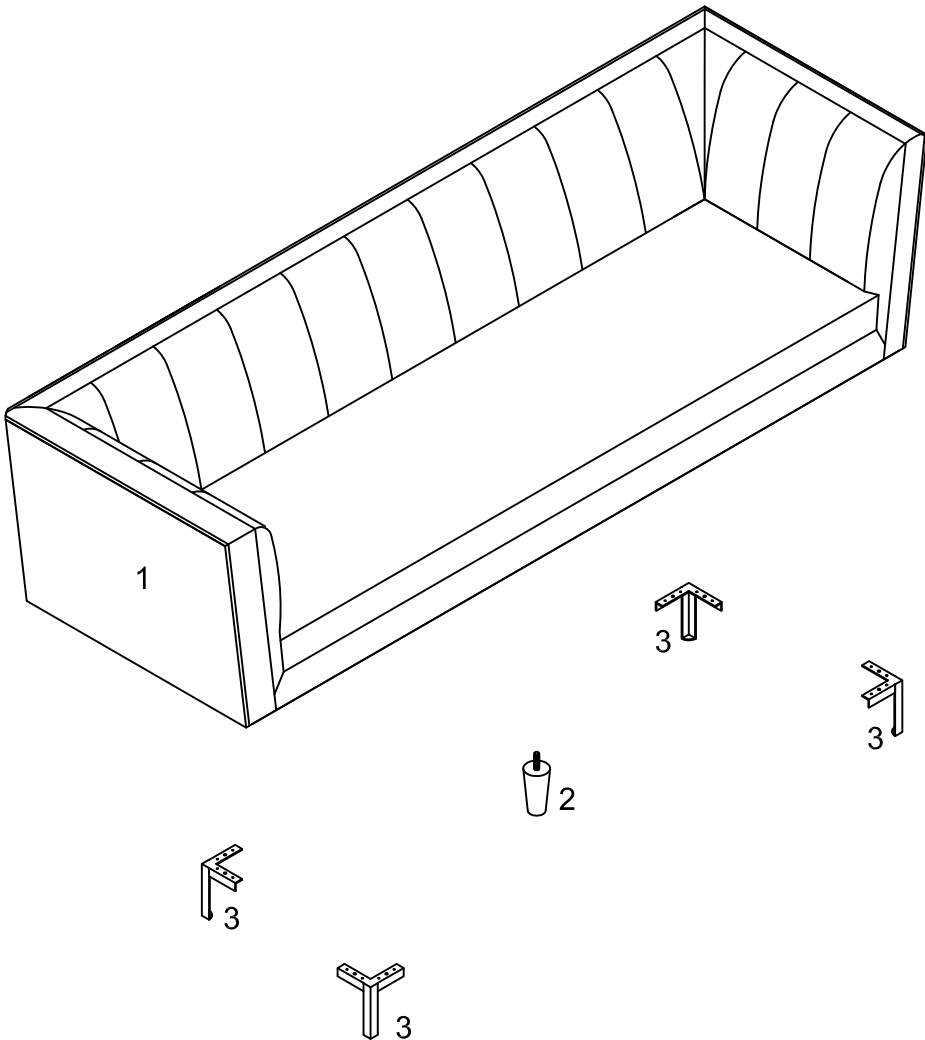

ITEM#: 8086-3



- (1) 1pc
- (2) 1pcs
- (3) 4pcs

HARDWARE IDENTIFICATION

ITEM#: 8086-3

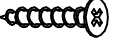
A		M6x25	8pcs
B			8pcs
C			8pcs
D		M4	1pc
E		ø7x25	16pcs

ASSEMBLY INSTRUCTION

ITEM#: 8086-3

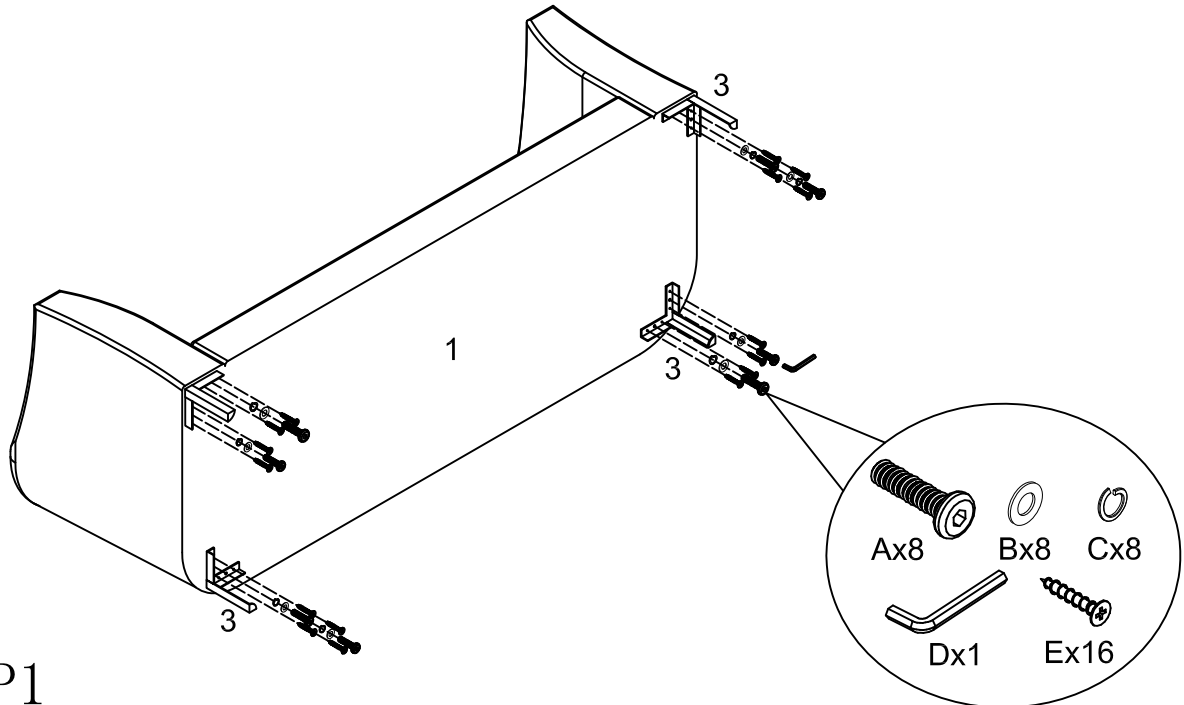

STEP 1

STEP 2

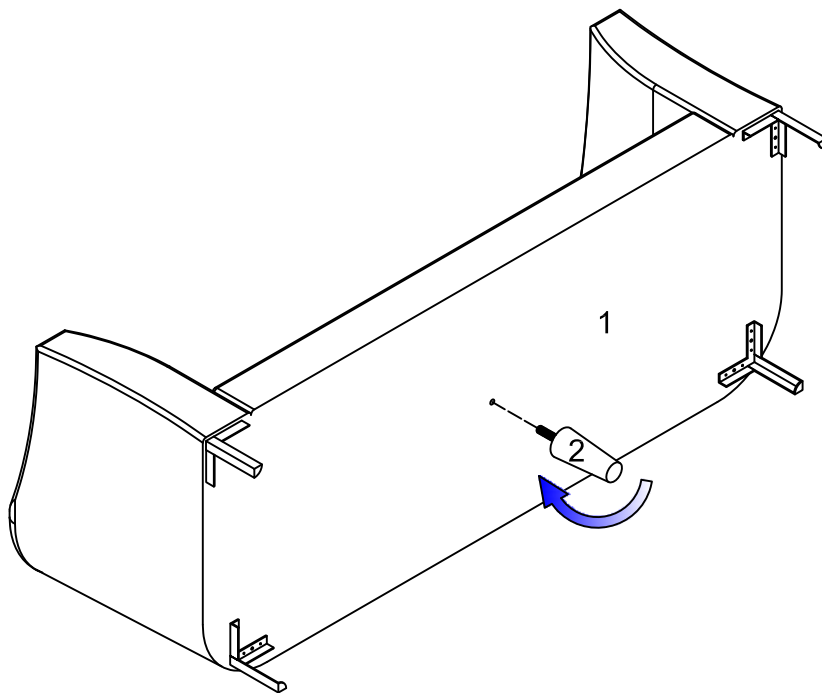

ASSEMBLY INSTRUCTION

ITEM#: 8086-3

STEP 3

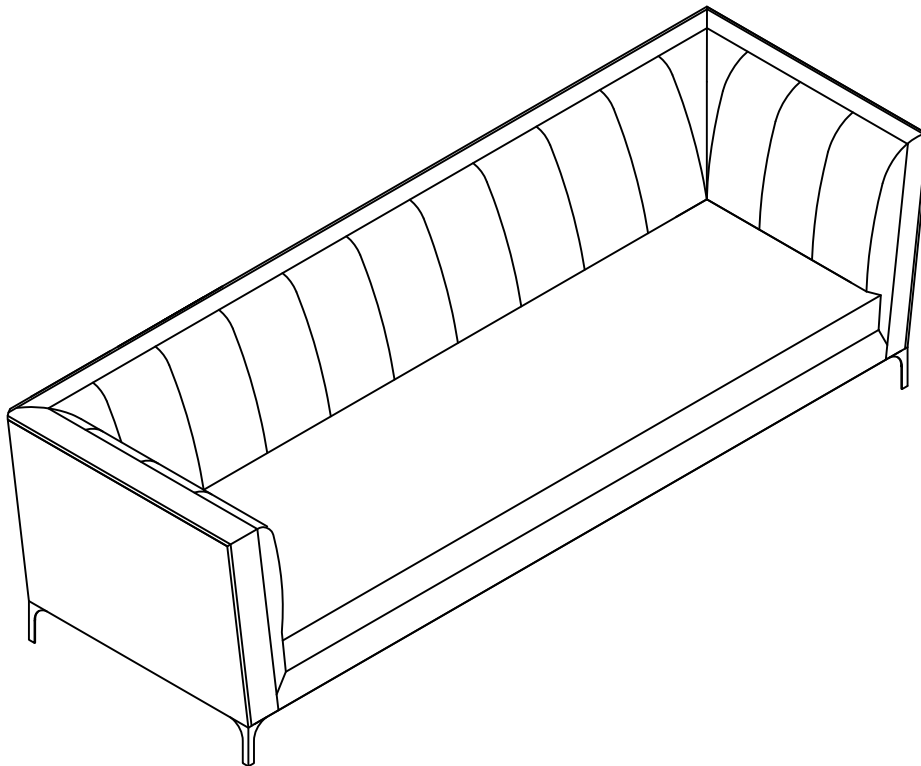

Assembly is complete.

Treat surfaces with care. wipe clean with a dry or damp soft cloth. Do not use abrasive cleaners.