

ASSEMBLY INSTRUCTION

PLEASE READ BEFORE ASSEMBLING!

Tip #1: Make sure you've taken all the pieces and hardware out of its packaging before discarding the box. Assembly on top of flattened box/blanket is recommended.

Tip #2: Using page 2 and/or page 3 of instruction manual make sure all pieces and hardware are accounted for.

Tip #3: Note position of all holes on each panel during assembly.

ITEM#: 8096-3

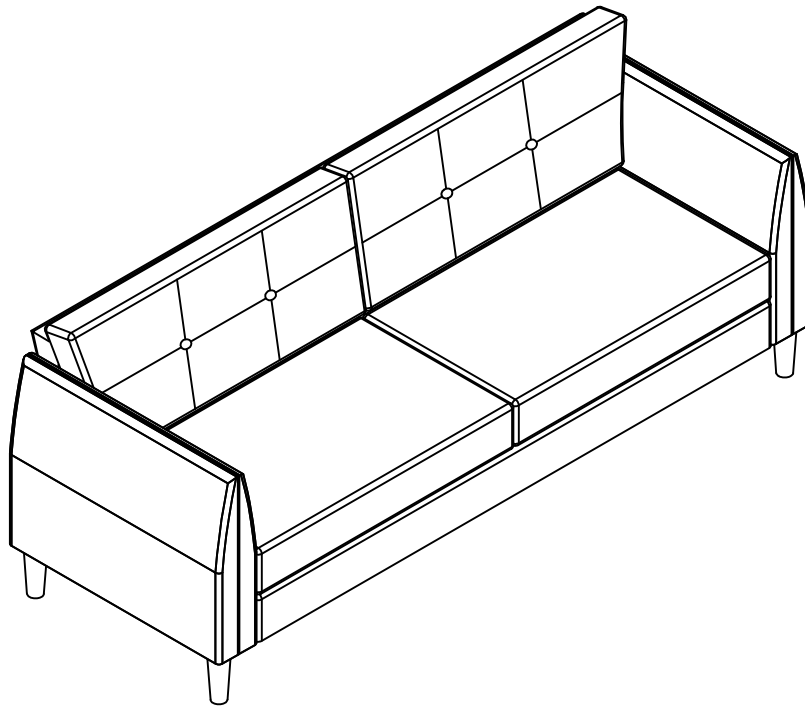

PARTS IDENTIFICATION

ITEM#: 8096-3

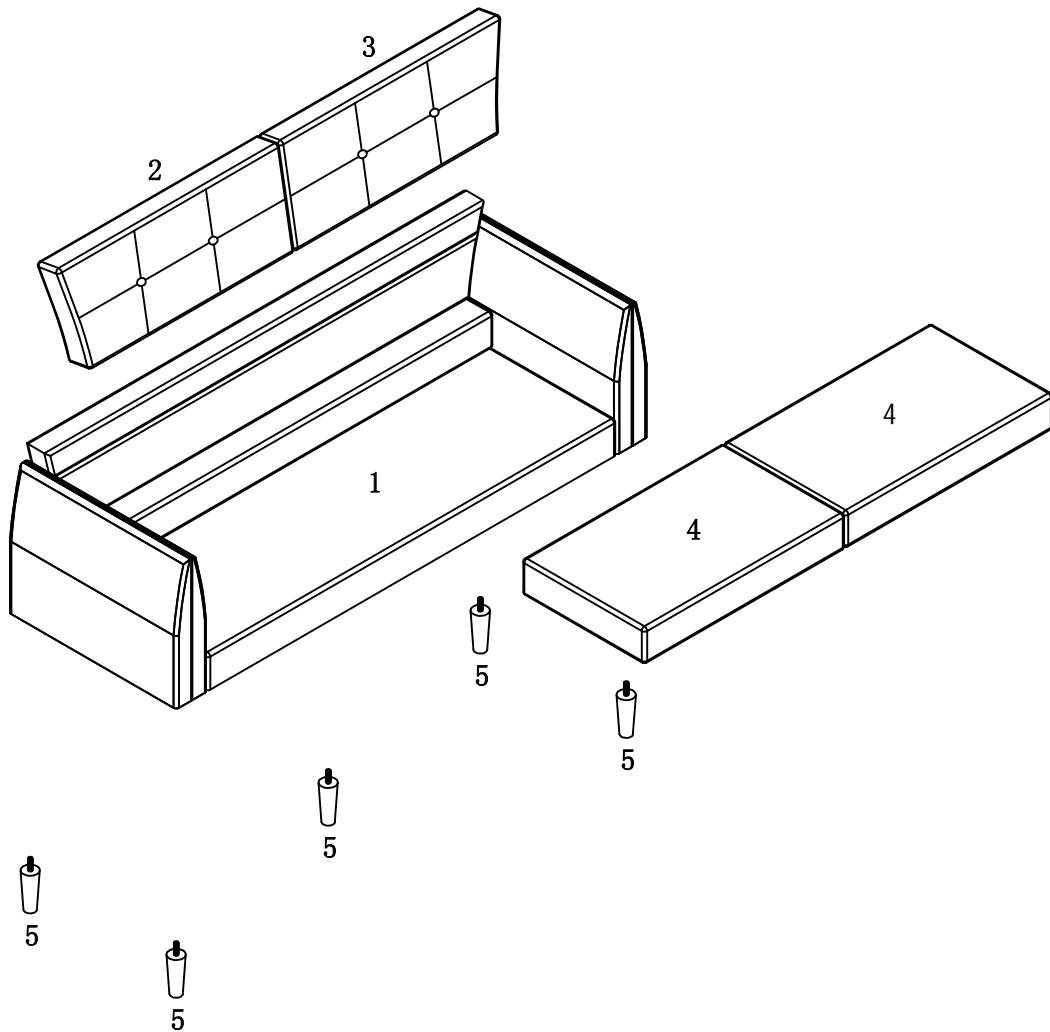

(1)	1pc	(4)	2pcs
(2)	1pc	(5)	5pcs
(3)	1pc		

ASSEMBLY INSTRUCTION

ITEM#: 8096-3

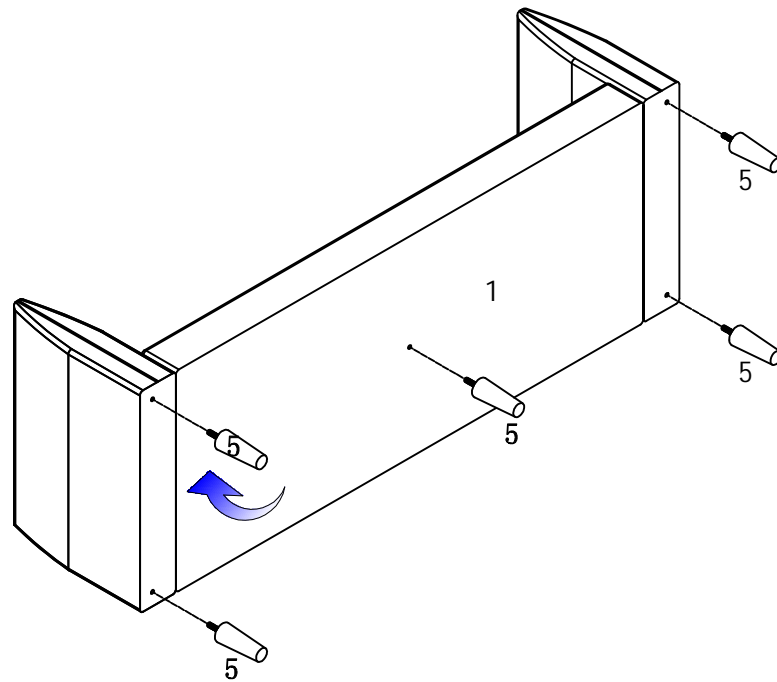

STEP1

STEP2

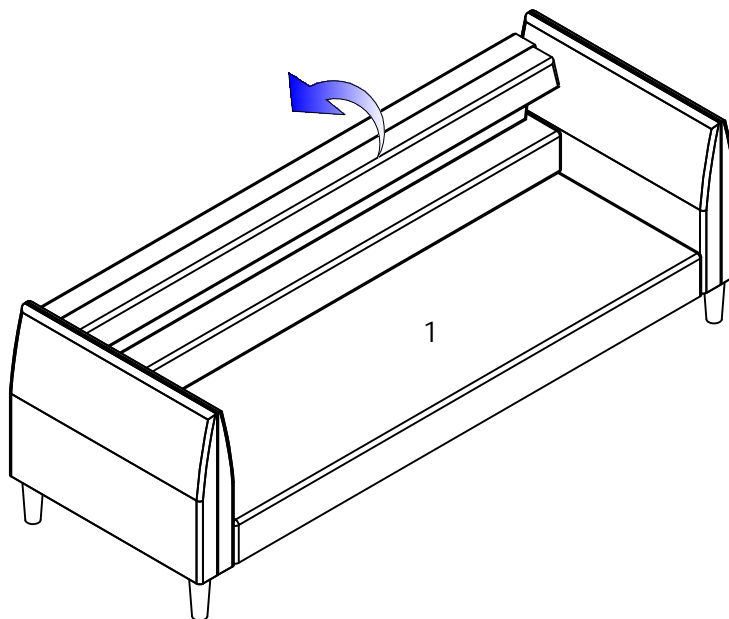

ASSEMBLY INSTRUCTION

ITEM#: 8096-3

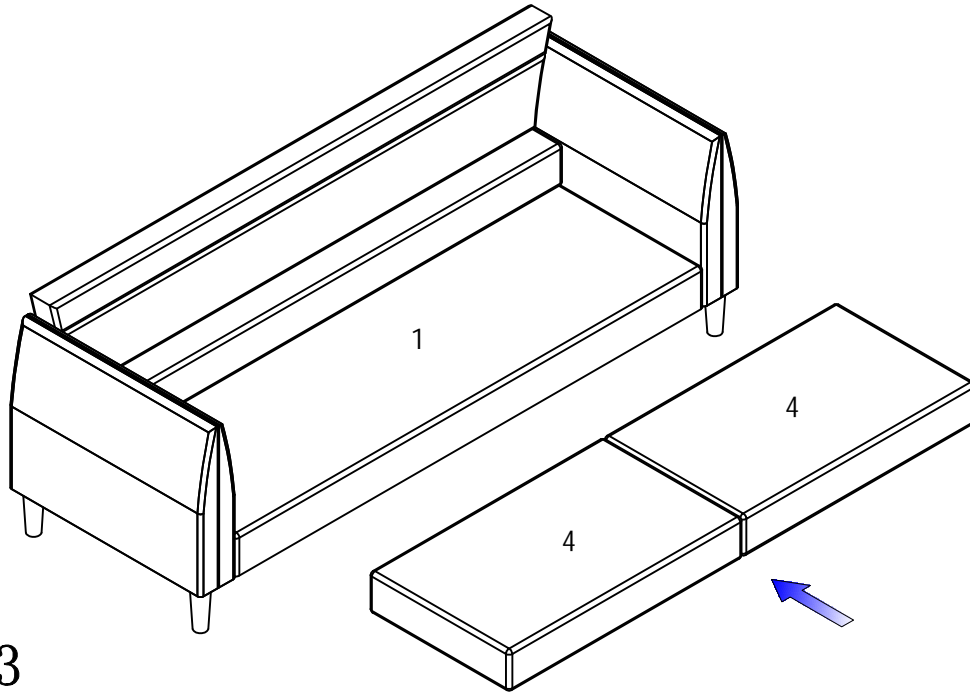

STEP3

STEP4

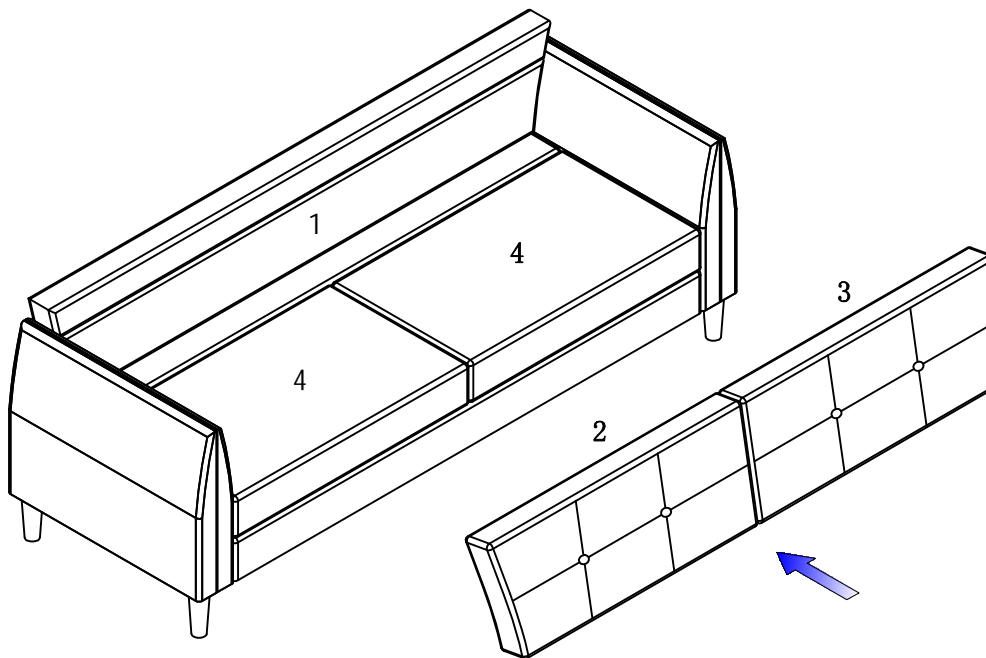

ASSEMBLY INSTRUCTION

ITEM#: 8096-3

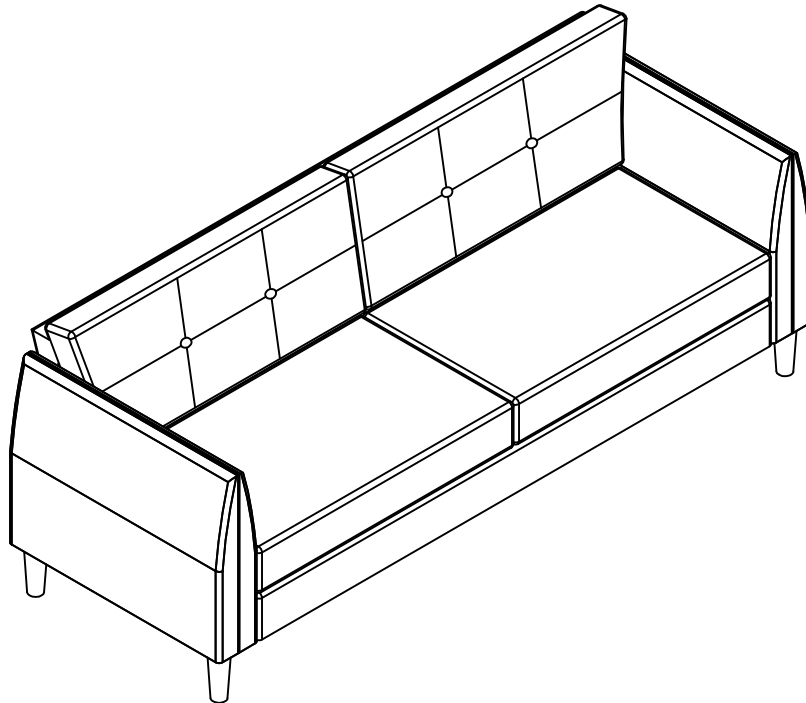

Assembly is complete.

Treat surfaces with care. wipe clean with a dry or damp soft cloth. Do not use abrasive cleaners.